

DRUM-TYPE GAS METERS
TG 1 STAINLESS STEEL 6 BAR • DATA-SHEET

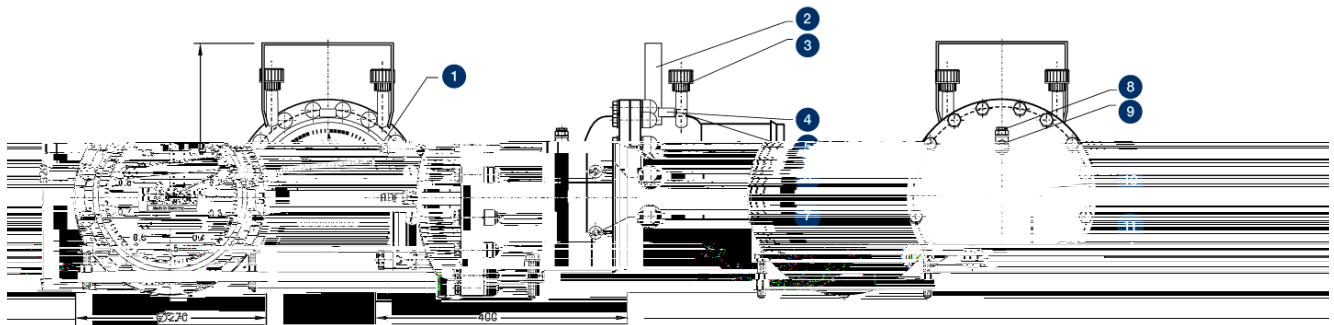

Legend

+

1. Filling level indicator
2. Handle
3. Support for gas & packing fluid thermometer
4. Filling nozzle
5. Level
6. Removable cover
7. Pulse generator port (option)
8. Manometer connection
9. Gas inlet
10. Gas outlet
11. Drainage faucet
12. Levelling foot

Performance Data

Minimum flow Q_{\min}	2 ltr/h	Maximum gas inlet pressure	6 bar
Standard flow Q_{standard}	100 ltr/h	Minimum differential pressure ⁽¹⁾	0.2 mbar
Maximum flow Q_{\max}	120 ltr/h	Minimum dial division	0.01 ltr
Measurement accuracy at standard flow	0.2 %	Maximum indication value ⁽²⁾	99,999,999 ltr
Measurement accuracy across measuring range	0.5 %	Connection gas in/outlet	hose barb
Measuring drum volume	1 ltr/U	Inside-Ø hose barb	
Packing liquid quantity, approx	4 ltr	Outside-Ø	12 mm

⁽¹⁾ Differential pressure (= pressure loss) gas inlet gas outlet

⁽²⁾ Standard Totalizing Roller Counter

Models (materials)

Model	Casing	Measuring drum	Width	Height	Depth	Weight (without packing liquid)	Max. constant use temperature
1	Stainless Steel	PVC-grey	270 mm	320 mm	400 mm	14.0 kg	50 °C
2	Stainless Steel	PE-el	270 mm	320 mm	400 mm	13.9 kg	60 °C
3	Stainless Steel	PP-grey	270 mm	320 mm	400 mm	13.9 kg	60 °C
4	Stainless Steel	PVDF	270 mm	320 mm	400 mm	14.2 kg	60 °C

Caution

Before and after measurements with **oxygen** purge the meter with an inert gas to avoid the danger of **explosion!**

For chemical resistance properties please contact your RITTER distribution partner!

Standard Equipment

- > 8-digit Totalizing Roller Counter
- > Bubble level for levelling
- > Level and Levelling Feet
- > Magnetic Coupling (between the measuring drum and counting mechanism) , for an absolutely liquid-tight casing
- > Multi-Chamber Measuring Drum
- > Supports for Thermometer and Manometer
- > Viton sealing

Built-in Options

- > Pulse Generator , standard or Ex-proof version (for connecting Electronic Display Unit/Computer)
- > LCD Display , resettable, 8-digit (replaces Totalizing Roller Counter)
- > High Precision Packing Liquid Level Indicator »HPLI«, for packing liquid level

Accessories

- > Data Acquisition Software »RIGAMO«, (for Windows)
- > Thermometer Gas (TG) , measuring range 0 °C to +60 °C
- > Thermometer Packing Liquid (TG) , measuring range 0 °C to +60 °C
- > Manometer for pressure $p_{max} \leq 10$ bar , measuring range 0-6 / 0-10 bar; available for higher pressure ranges
- > Electronic Display Unit »EDU 32 FP«, displays volume and calculates flow rate via RS232 and analog-output in realtime (pulse generator required)

V 1.2 / Rev. 2019-01-14 / Subject to alterations.

The most recent version of this data-sheet can be found at <https://www.ritter.de/en/data-sheets/tg-1-stainless-steel-6-bar/>

Dr.-Ing. RITTER Apparatebau GmbH & Co. KG · Coloniastrasse 19-23 · D-44892 Bochum · Germany

For questions please contact mailbox@ritter.de or your any local distributor at <https://www.ritter.de/en/worldwide/>