

TG 20 Stainless steel 6 bar

RITTER DATA SHEET

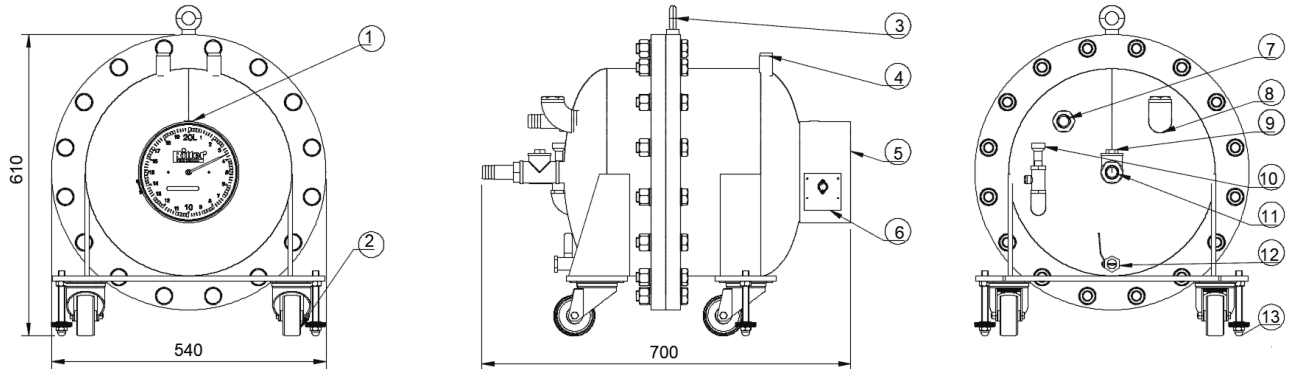

Legend

1. Level
2. Transport roll
3. Eye screw
4. Support for thermometer G 1/2 i
5. Removable cover
6. Pulse generator port (option)
7. Gas outlet
8. Filling nozzle
9. Support for manometer G 3/8 i
10. Packing liquid level indicator
11. Gas inlet
12. Drainage faucet
13. Leveling foot

Performance Data

Minimum flow Q_{\min}	40	ltr/h
Standard flow Q_{standard}	3,200	ltr/h
Maximum flow Q_{\max}	4,000	ltr/h
Measurement accuracy at standard flow	0.2	%
Measurement accuracy across measuring range	0.5	%
Measuring drum volume	20	ltr/U
Packing liquid quantity, approx	29	ltr
Maximum gas inlet pressure	6	bar
Minimum differential pressure ⁽¹⁾	0.1	mbar
Minimum dial division	0.2	ltr
Maximum indication value ⁽²⁾	999,999,990	ltr
Connection gas in/outlet	hose barb	
Inside-Ø hose barb	18	mm
Outside-Ø hose barb	26	mm

⁽¹⁾ Differential pressure (= pressure loss) gas inlet gas outlet

⁽²⁾ Standard Totalizing Roller Counter

Models (materials)

Model	Casing	Measuring drum	Width	Height	Depth	Weight (without packing liquid)	Max. constant use temperature
1	Stainless Steel	PVC-grey	540 m m	610 m m	700 m m	93.9 kg	40 °C
2	Stainless Steel	PE-el	540 m m	610 m m	700 m m	93.5 kg	60 °C
3	Stainless Steel	PP-grey	540 m m	610 m m	700 m m	93.5 kg	60 °C
4	Stainless Steel	PVDF	540 m m	610 m m	700 m m	94.7 kg	60 °C

Caution

Before and after measurements with oxygen purge the meter with an inert gas to avoid the danger of explosion!

For chemical resistance properties please contact your RITTER distribution partner!

Standard Equipment

- > Multi-Chamber Measuring Drum
- > Magnetic coupling between measuring drum and counter (for an absolutely liquid-tight casing)
- > 8 or 9-digit Totalizing Roller Counter
- > Large One-needle Dial
- > Supports for Thermometer and Manometer
- > Viton sealing
- > Level and Levelling Feet
- > Bubble level for levelling

Built-in Options

- > **LCD Display**, resettable, 8-digit (replaces Totalizing Roller Counter)
- > **Pulse Generator**, standard or Ex-proof version (for connecting Electronic Display Unit/Computer)

Accessories

- > **Software »RIGAMO«**
- > Resistance Temperature Sensor (Gas), 100 mm
- > Resistance Temperature Sensor (Packing Liquid), 200 mm
- > Pressure Transmitter
- > **Electronic Display Unit »EDU 32 FP«**, displays volume and calculates flow rate via RS232 and analog-output in realtime (pulse generator required)

V 1.0 / Rev. 2024-02-07 / Subject to alterations.

The most recent version of this data-sheet can be found at ...

<https://www.ritter.de/en/tg-20-stainless-steel-6-bar/>

Dr.-Ing. RITTER Apparatebau GmbH & Co. KG · Coloniastrasse 19-23 · D-44892 Bochum · Germany

For questions please contact mailbox@ritter.de or your local distribution partner ([on our overview page](#))