

TG 20 Plastic

RITTER DATA SHEET

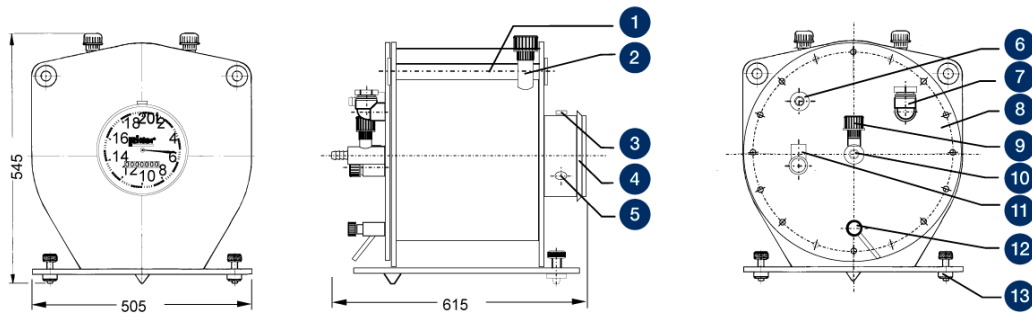

Technical Drawing



Legend

1. Handle
2. Support unit for:
 - > Thermometer (gas)
 - > Thermometer (packing liquid)
 - > Manometer
3. Level
4. Removable cover
5. Pulse generator port (option)
6. Gas outlet
7. Filling nozzle
8. Rear plate, detachable
9. Manometer connection
10. Gas inlet
11. Liquid level indicator
12. Drainage faucet
13. Levelling foot

Performance Data

Minimum flow Q_{\min}	40	ltr/h
Standard flow Q_{standard}	3,200	ltr/h
Maximum flow Q_{\max}	4,000	ltr/h
Measurement accuracy at standard flow	± 0.2	%
Measurement accuracy across measuring range	± 0.5	%
Measuring drum volume	20	ltr/U
Packing liquid quantity, approx	28.5	ltr
Maximum gas inlet pressure	50	mbar
Minimum differential pressure ⁽¹⁾	0.1	mbar
Minimum dial division	0.2	ltr
Maximum indication value ⁽²⁾	999,999,990	ltr
Connection gas in/outlet	hose barb	
Inside-Ø hose barb	19	mm
Outside-Ø hose barb	25	mm

⁽¹⁾ Differential pressure (= pressure loss) gas inlet gas outlet

⁽²⁾ Standard Totalizing Roller Counter

Models (materials)

Model	Casing	Measuring drum	Width	Height	Depth	Weight (without packing liquid)	Max. constant use temperature
5	PVC-transparent	PVC-grey	505 mm	545 mm	615 mm	18.0 kg	40 °C
6	PP-grey	PP-grey	505 mm	545 mm	615 mm	13.4 kg	60 °C
7	PVDF	PVDF	505 mm	545 mm	615 mm	23.2 kg	80 °C
8	PE-el	PE-el	505 mm	545 mm	615 mm	13.4 kg	80 °C

Caution: Before and after measurements with oxygen purge the meter with an inert gas to avoid the danger of explosion! For chemical resistance properties please contact your RITTER distribution partner!

Standard Equipment

- › Multi-Chamber Measuring Drum
- › Magnetic coupling between measuring drum and counter (for an absolutely liquid-tight casing)
- › 8 or 9-digit Totalizing Roller Counter
- › Large One-needle Dial
- › Supports for Thermometer and Manometer
- › Viton sealing
- › Level and Levelling Feet
- › Bubble level for levelling

Built-in Options

- › **LCD Display**, resettable, 8-digit (replaces Totalizing Roller Counter)
- › **Pulse Generator**, standard or Ex-proof version (for connecting Electronic Display Unit/Computer)
- › **High Precision Packing Liquid Level Indicator »HPLI«**, for packing liquid level

Accessories

- › **Software »RIGAMO«**
- › **Thermometer Gas (TG)**, measuring range 0 °C to +60 °C
- › **Thermometer Packing Liquid (TG)**, measuring range 0 °C to +60 °C
- › **Manometer for pressure $p_{max} \leq 50$ mbar**, measuring range 0-10 / 0-20 / 0-50 mbar
- › **Electronic Display Unit »EDU 32 FP«**, displays volume and calculates flow rate via RS232 and analog-output in realtime (pulse generator required)

V 2.1 / Rev. 2024-02-07 / Subject to alterations.

The most recent version of this data-sheet can be found at ...

<https://www.ritter.de/en/tg-20-plastic/>

Dr.-Ing. RITTER Apparatebau GmbH & Co. KG · Coloniastrasse 19-23 · D-44892 Bochum · Germany

For questions please contact mailbox@ritter.de or your local distribution partner ([on our overview page](#))